

# 51266

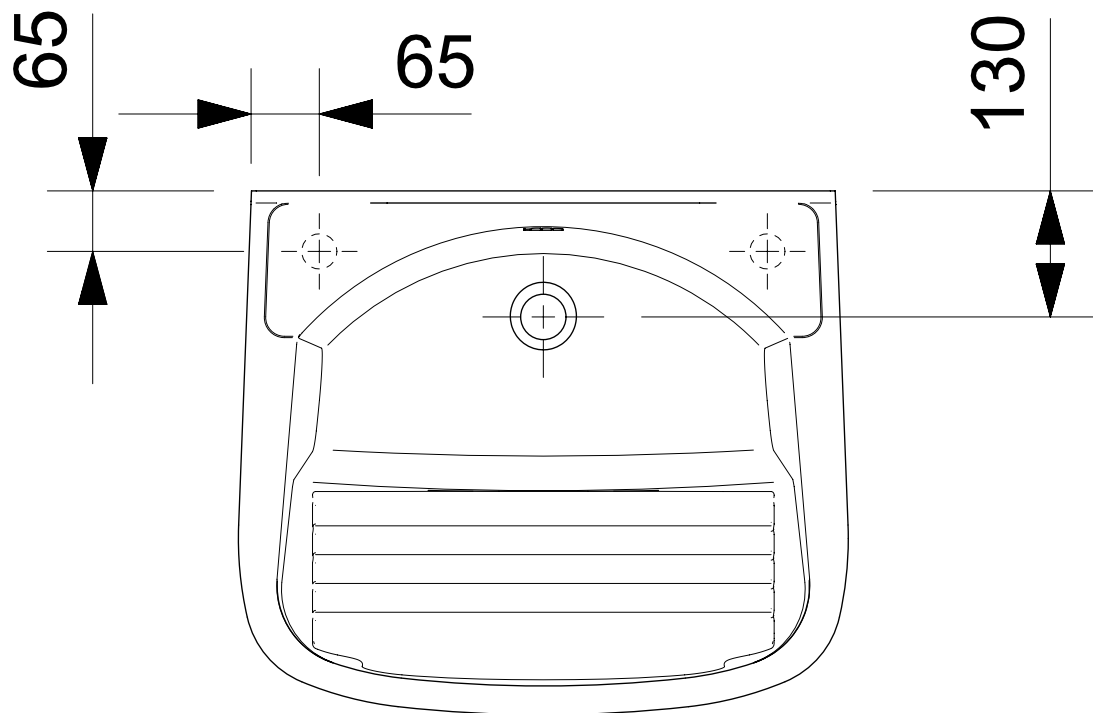
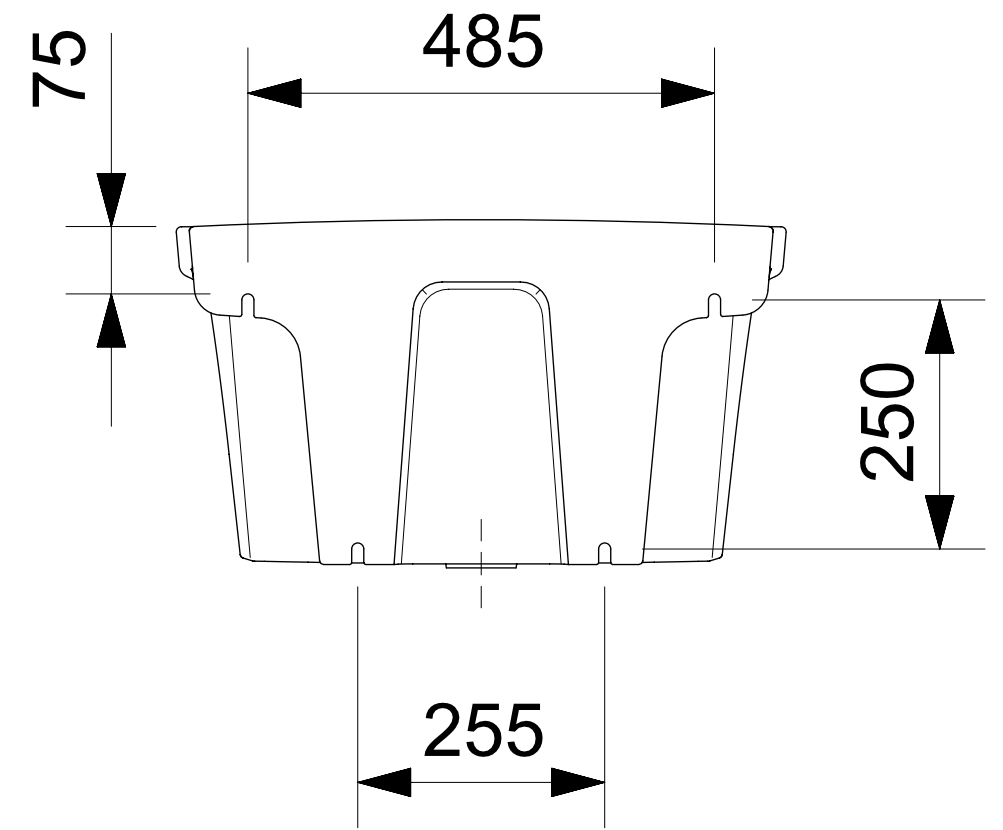
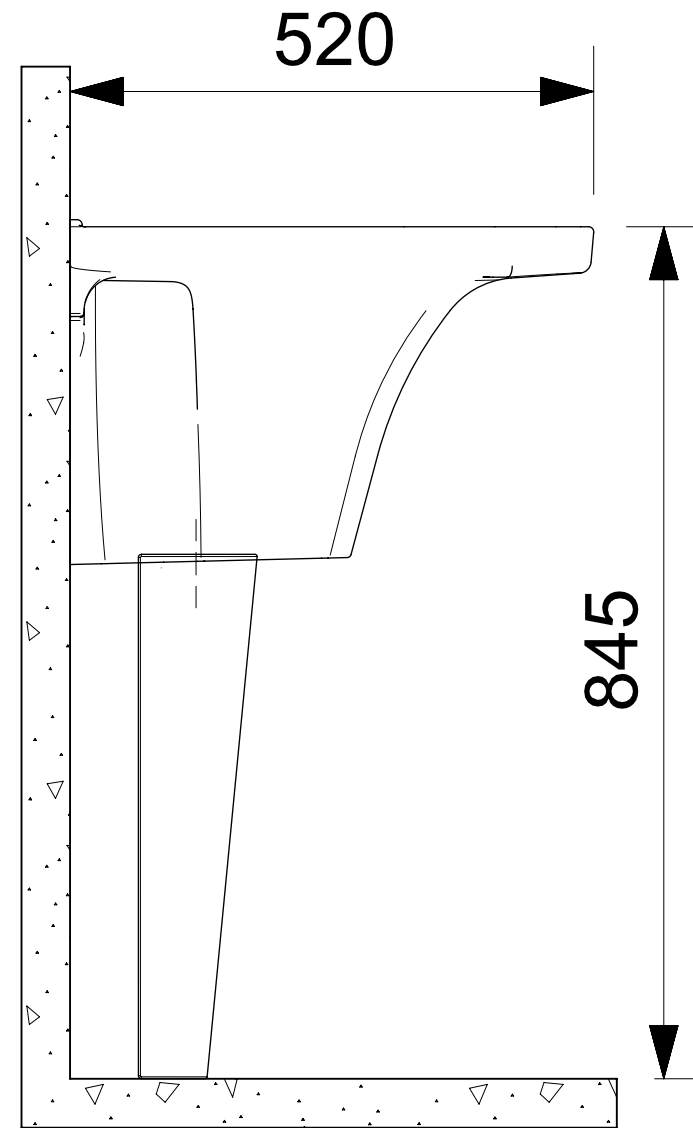
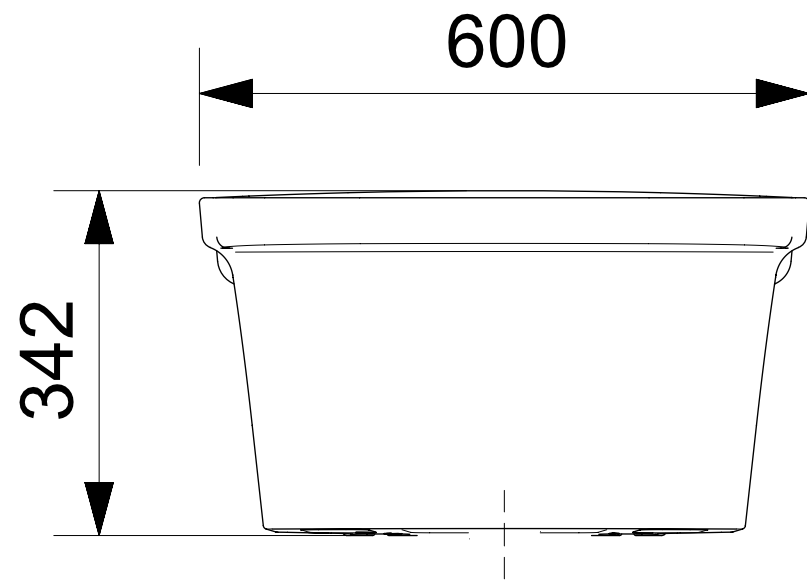

OBS.: Todas as medidas acima contém tolerância de +/- 10mm.